

## 1. 安装万向轮

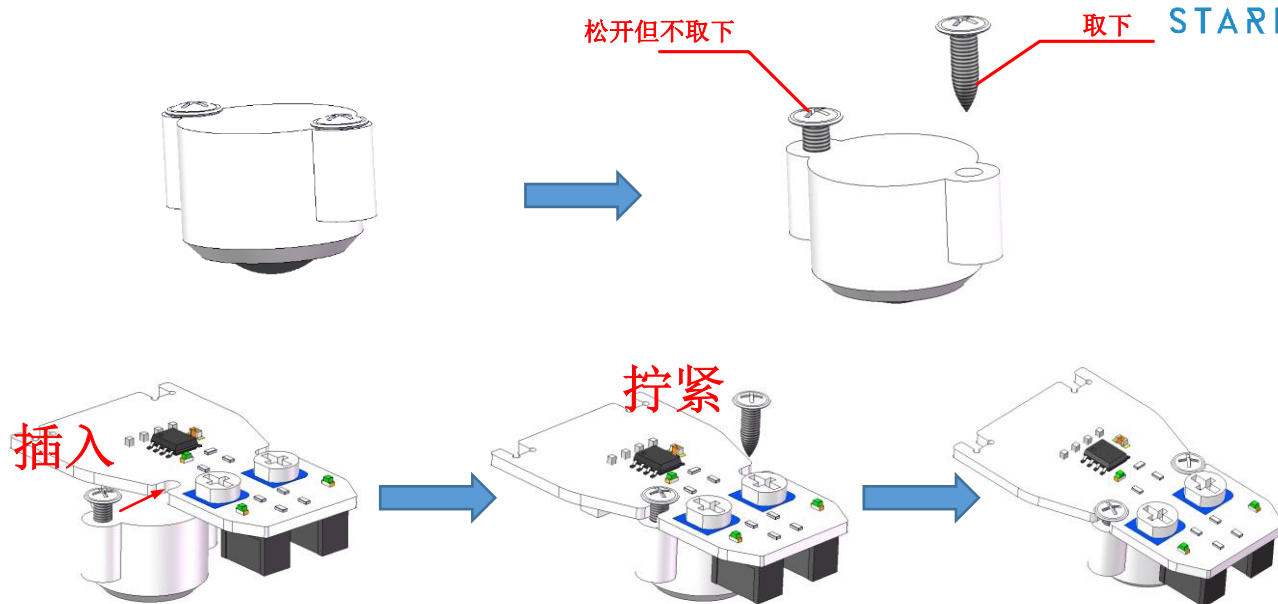

STARLAB



## 2. 安装巡线模块

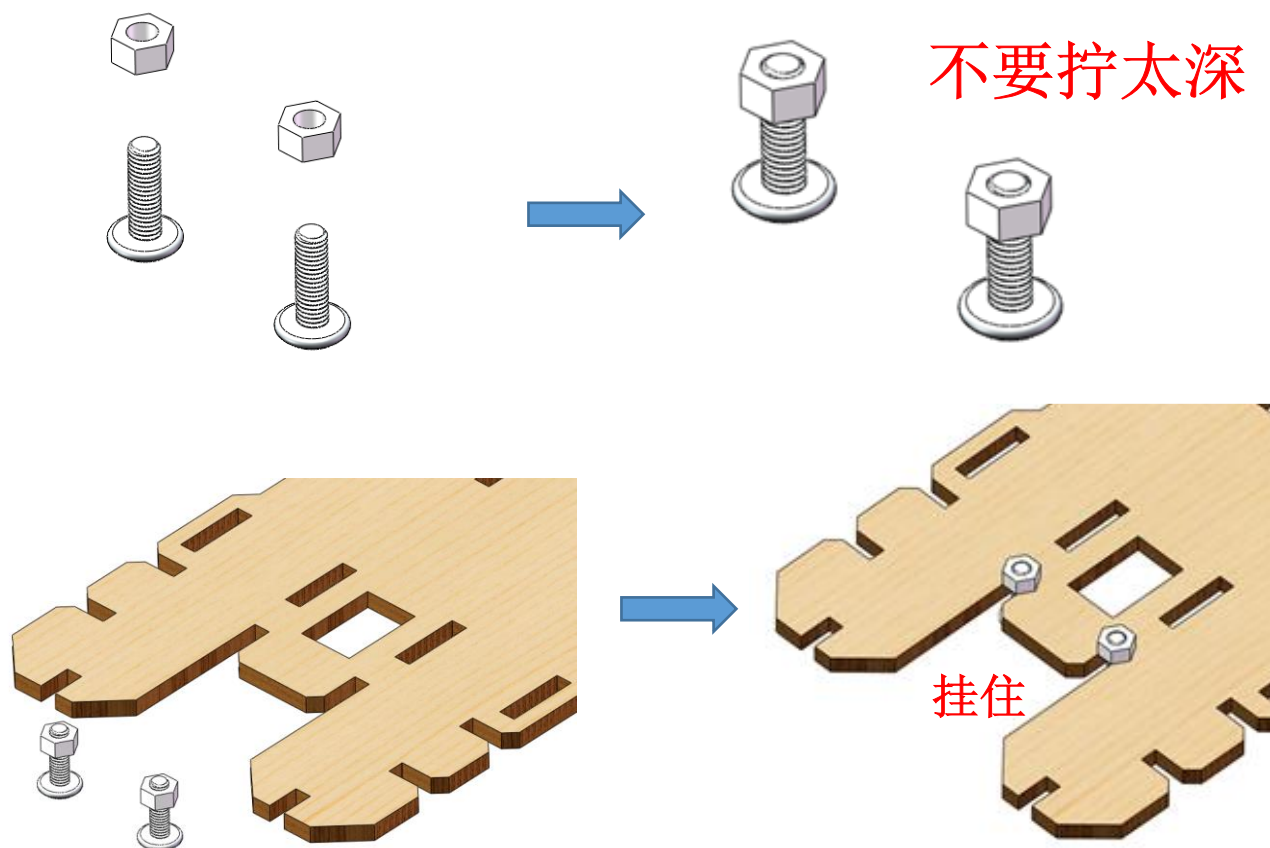

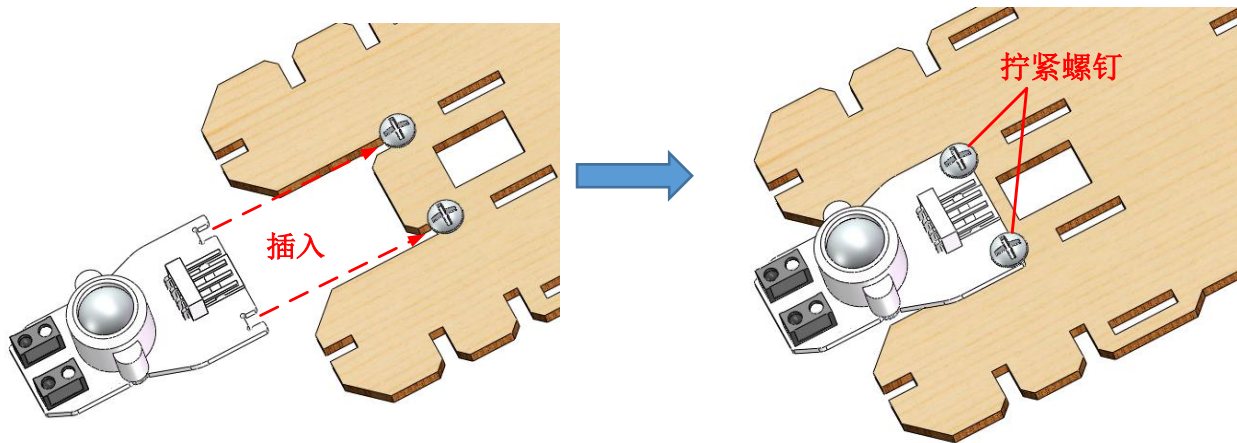

### 3. 安装电机

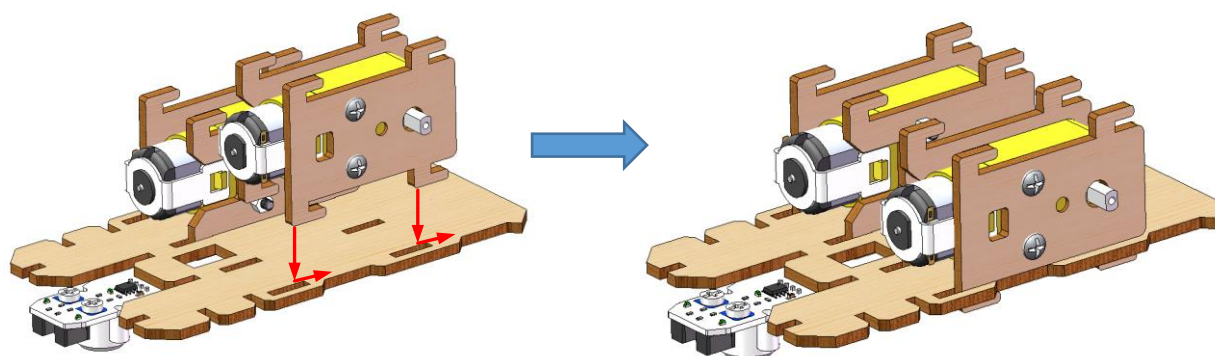
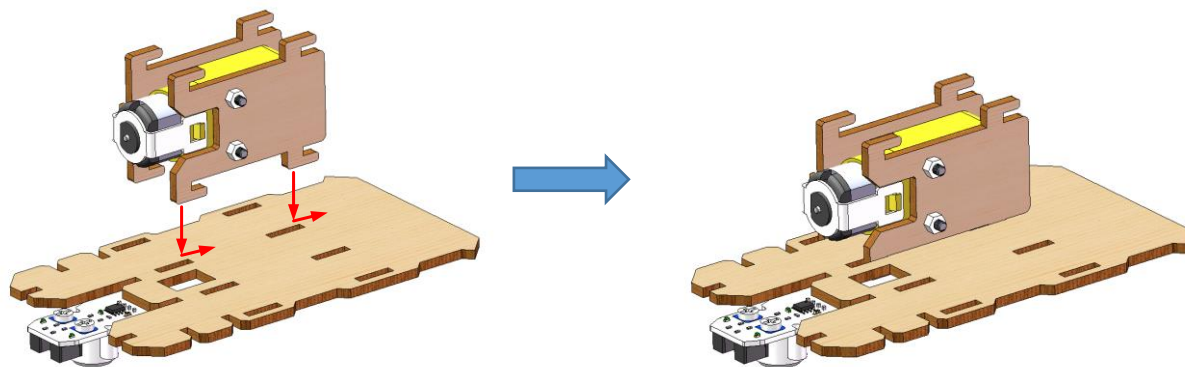
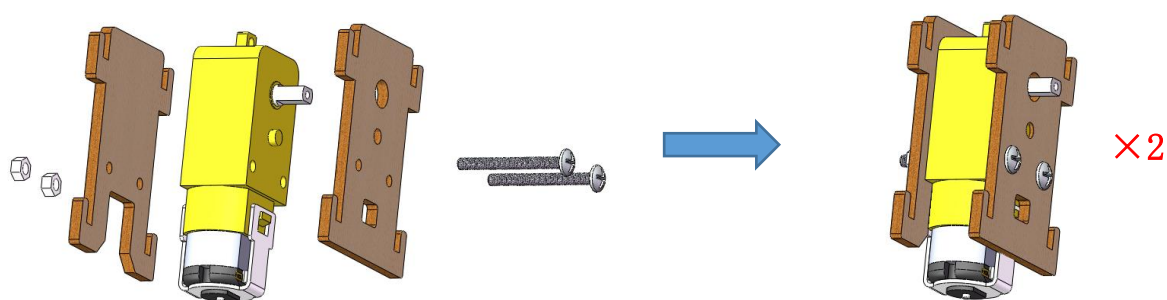

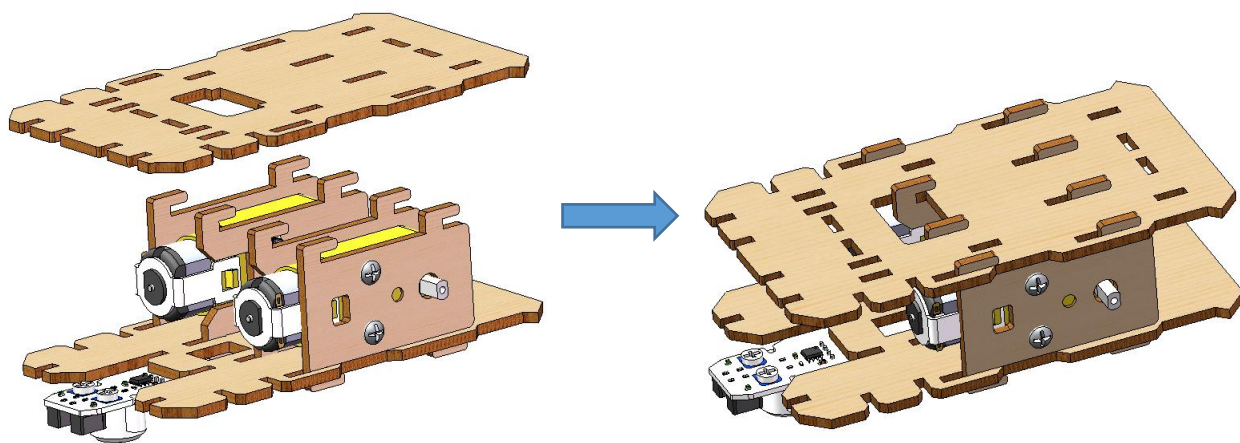

#### 4. 安装外围框架

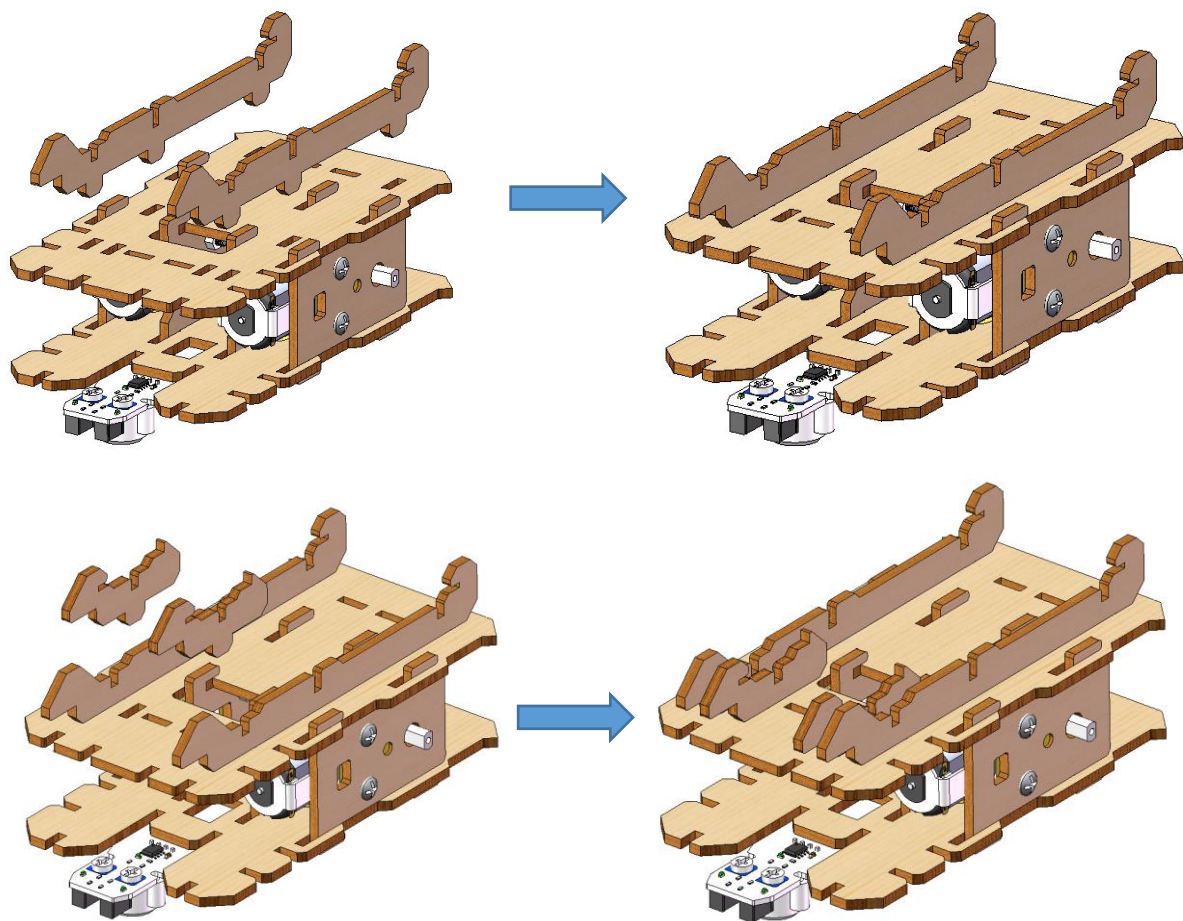



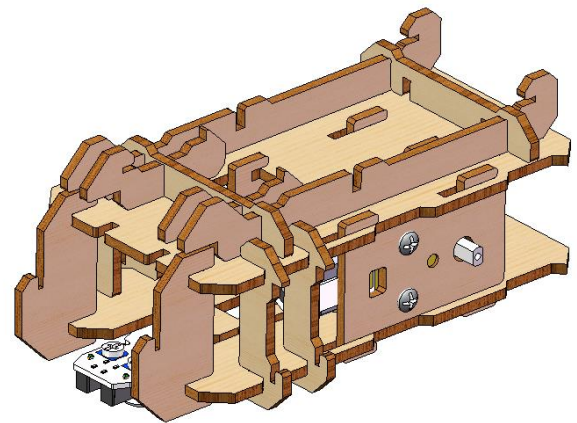
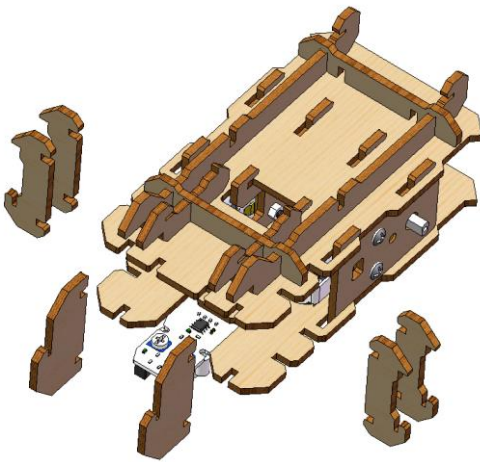
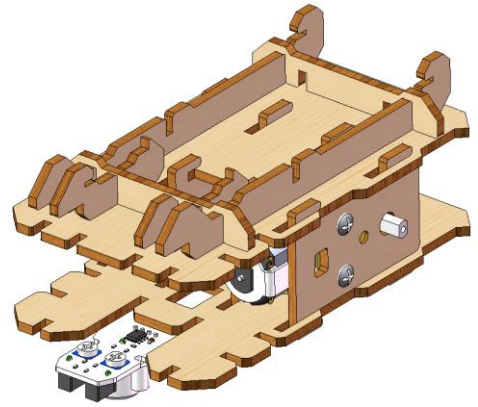
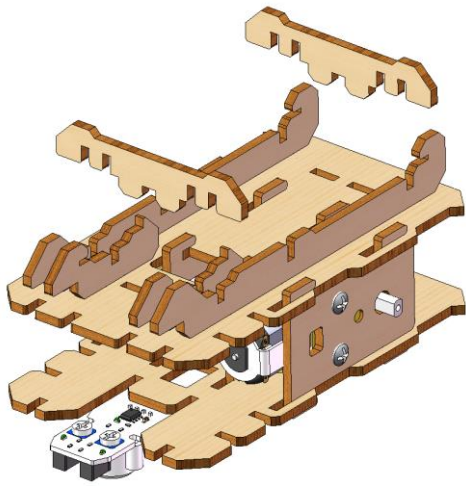

#### 4. 安装电子模块

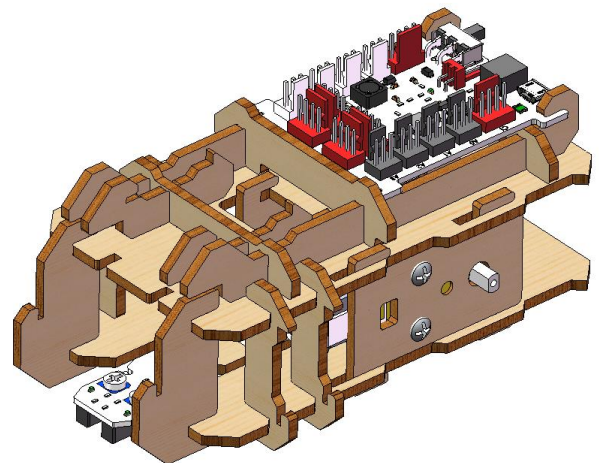
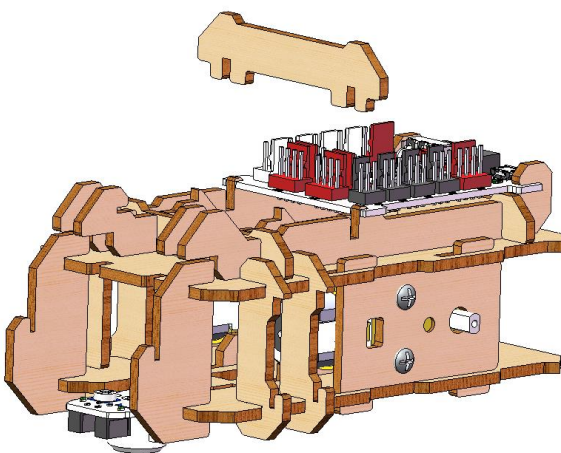
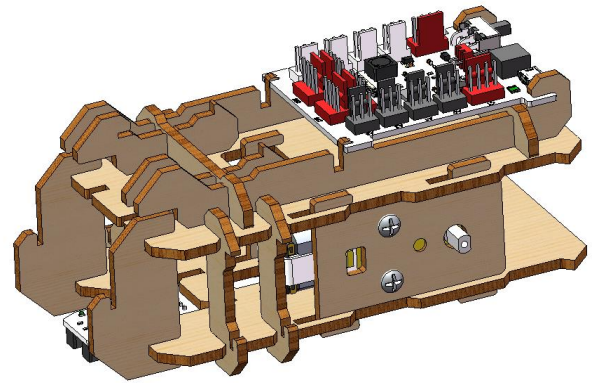
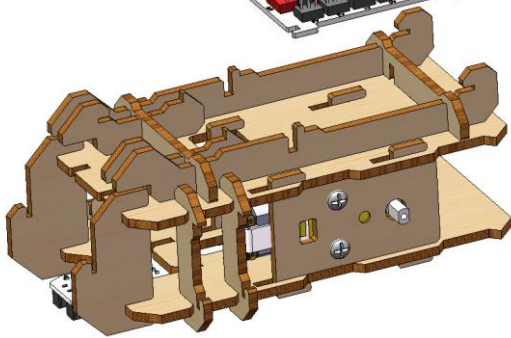
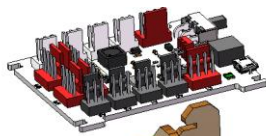



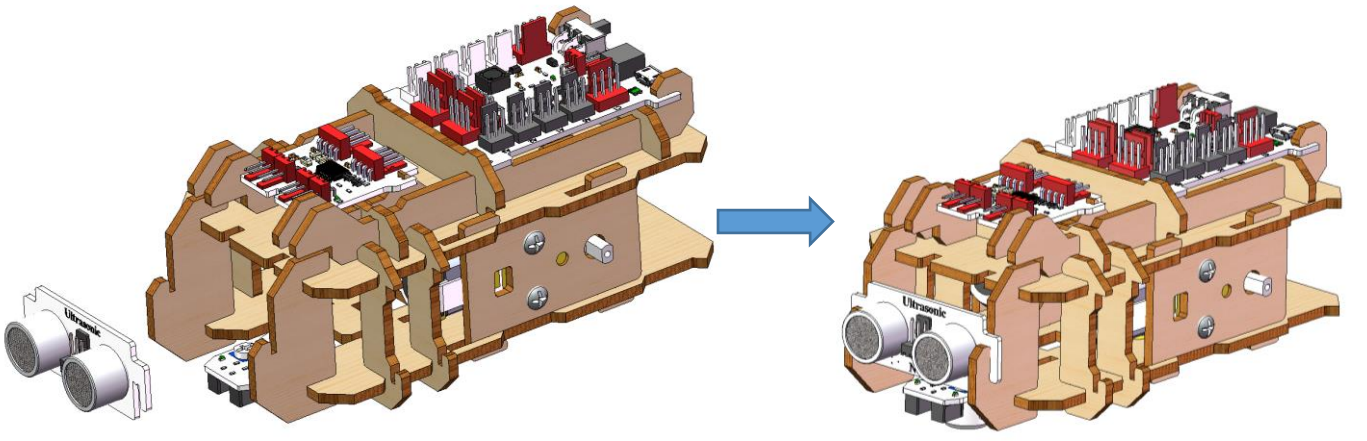
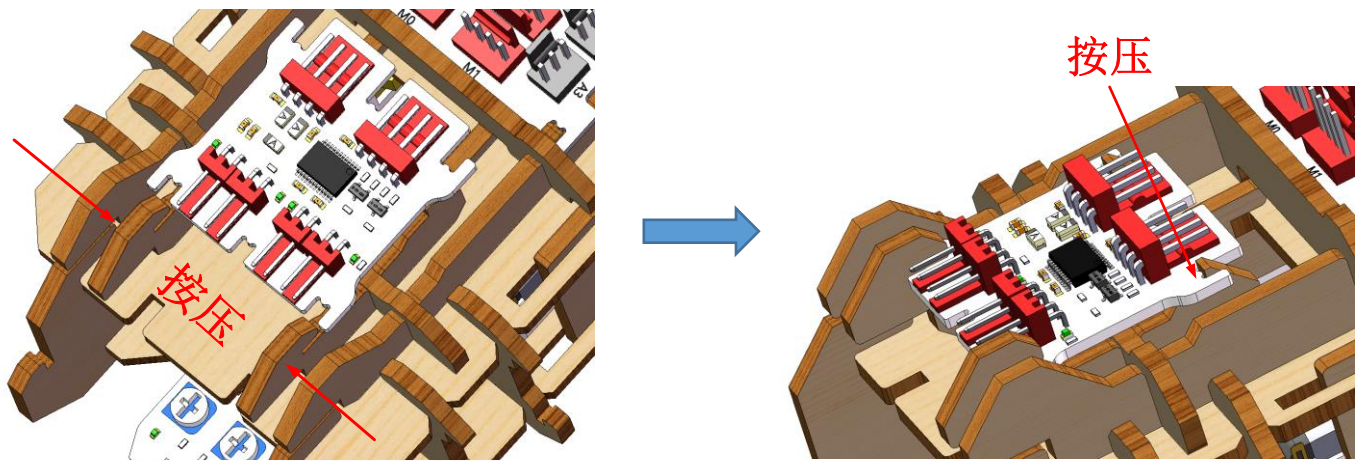

## 5. 安装轮胎

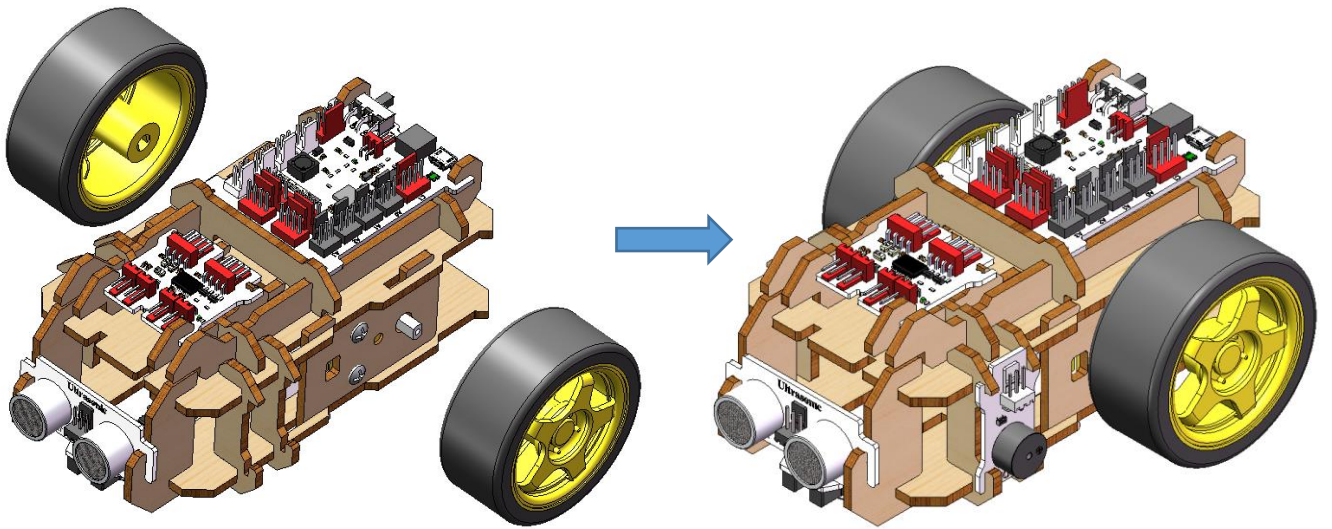

## 6. 电路连接

